



  
made in Italy  
since 1969

Vertrieb + Beratung:



[www.rise-consult.de](http://www.rise-consult.de)

Edition 2014



Vertrieb + Beratung:



[www.rise-consult.de](http://www.rise-consult.de)

# EUROGAMES > HISTORY > STORIA

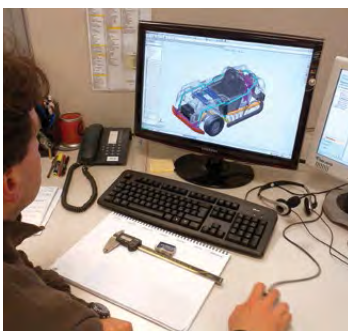

EuroGames started its production in 1969 with a revolutionary – for its time – battery car for children. The managing Director Fabio De Carlo, son of the founder, continued manufacturing new and attractive models and products with original elements which have made Eurogames products well-known all over the world. Eurogames has achieved international leadership in its branch through high standard production, accurate planning, motivated and qualified team of designers, mechanical and electronic engineers, sales management, partnership with international dealers.

*Eurogames ha iniziato la produzione nel 1969 con una rivoluzionaria - per l'epoca - macchinina a batteria. Il Sig. Fabio De Carlo - figlio del fondatore - continua a sviluppare l'attività con la progettazione e produzione di nuovi modelli, robusti ed attraenti che hanno reso i prodotti Eurogames ben conosciuti in tutto il mondo. Eurogames ha raggiunto la leadership internazionale nel suo settore grazie agli elevati standard di qualità, al team motivato e qualificato di progettisti, ingegneri meccanici ed elettronici, al commerciale, alle partnership con i rivenditori internazionali.*



## PRODUCTION

EuroGames projects, produces and sales worldwide about 100 products divided in 7 categories:  
 Mini Battery cars & Bikes,  
 Go-karts for adults, Big cars,  
 Bumper boats,  
 Bumper cars, Tracks & pools,  
 Decoration & Settings.

## PRODUZIONE

*Eurogames, produce e vende in tutto il mondo circa 100 prodotti - sia standard che personalizzati - divisi in 7 categorie:  
 Mini car e mini moto, Scuola Guida per bambini, go-kart per adulti, bumper boat, Bumper car, piste e piscine, Decorazione e scenografie.*



# NEW

**THE ORIGINAL**  
**THE MOST ADVANCED**  
**THE ONLY ONE WITH THE SHOOTING SYSTEM**

## BUMPER CAR

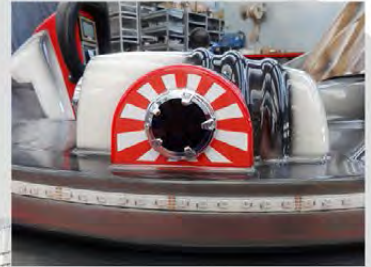

**ORIGINAL**

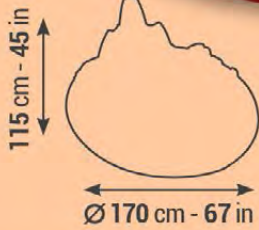

## MINI BUMPER CAR



Vertrieb + Beratung:  
**RISE**  
[www.rise-consult.de](http://www.rise-consult.de)

More details from page 34.

# minicar > 2 SEATER

Qualità e design sempre un passo avanti.

IL TOP DEL MADE IN ITALY



**FARM TRACTOR**  
PC4-6460

**OFF ROAD**  
PC4-C350

**CABRIO 24 V - 780W**  
PC4-6350

**BUGGY**  
PC4-6980

**EUROQUAD 2012**  
PC4-C351

EuroGames, first every time  
for customer care and product design.

TOP QUALITY MADE IN ITALY



**F1 V-MAX**  
PC4-C100

**F1 V-POWER**  
PC4-6009

**MINI GO KART (1seat)**  
PC4-6900

**TWIN**  
PC4-6950

**TWIN SPACE**  
PC4-6970

Vertrieb + Beratung:



[www.rise-consult.de](http://www.rise-consult.de)



**MINICAR 1 seat**

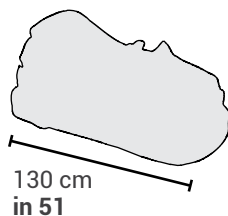

**MINICAR 2 seater**

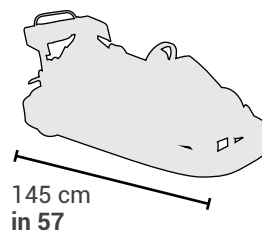

**MOTO 2 seater**

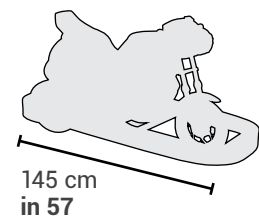

# minicar > MOTO 2 SEATER

detailed info from page 12  
vedi dettagli da pag. 12



**SUPER BIKE**  
PM4-M200

**GP**  
PM4-6650

**POLICE**  
PM4-M201

**CHOPPER**  
PM4-M202

**SPORTING**  
PM4-6750

**TRIKE**  
PM4-6550

# minicar > 1 SEAT



**RALLY**  
PC4-6006

**X3**  
PC4-6250

**MINI OFF ROAD**  
PC4-C150

**SPORT**  
PC4-6200

**DRIVING SCHOOL 2 seater**

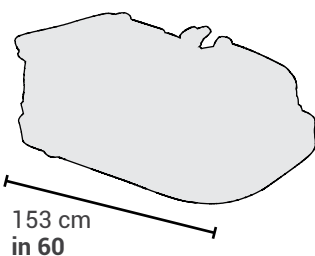

**GO KART 1/2 seater**

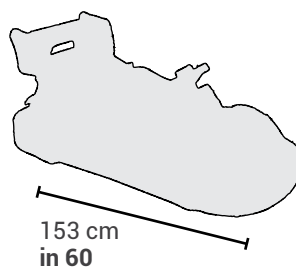

**BIG CAR 2 seater**

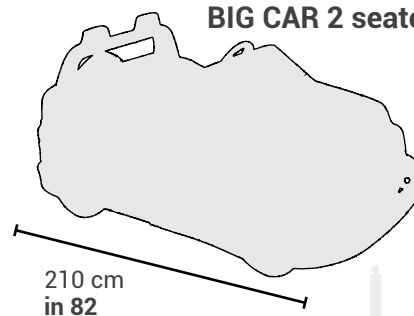

Vertrieb + Beratung:



[www.rise-consult.de](http://www.rise-consult.de)



# go kart > 1/2 SEATER



**GO KART - 1 seat**  
PK4 - 6800



**GO KART DOUBLE - 2 seater**  
PK4 - 6850

# big car > 2 SEATER



**SAFARI**  
PG4 - 6100



**CALIFORNIA**  
PG4 - 6300

Vertrieb + Beratung:  
**RISE**  
[www.rise-consult.de](http://www.rise-consult.de)



**GO KART**

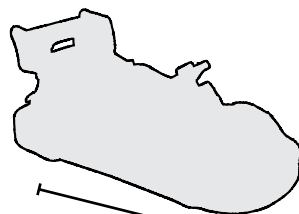

153 cm  
60 in

**BIG CAR**

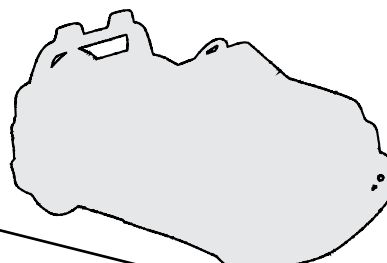

210 cm  
82 in

# bumper car > 2 SEATER



**BUMPER CAR**  
PB5-B500

**BUMPER CAR ICE**  
PB5-B501

**HYPER  
BUMPER CAR**  
PB5-B502



**BUMPER CAR 2 seater**

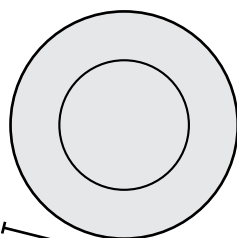

170 cm  
67 in

Vertrieb + Beratung:

**RISE**  
www.rise-consult.de



# bumper boat > 2 SEATER

**SPLASH**  
with watercannon  
+ paintwork  
PW5-B703

**SPLASH**  
PW5-B702

**CRAZY POLYP**  
PW5-7400

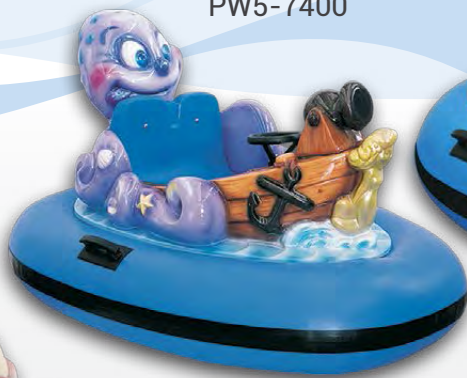

## READY TO SURF?

**HAPPY BEAR**  
PW5-7300



**FROG**  
PW5-7800



**SWAN**  
PW5-7700



**DOLPHINS**  
PW5-7600

Vertrieb + Beratung:  
**RISE**  
www.rise-consult.de



**BUMPER SPLASH 2 seats**

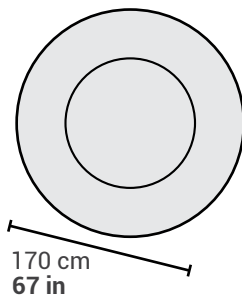

**BUMPER BOAT 2 seats**

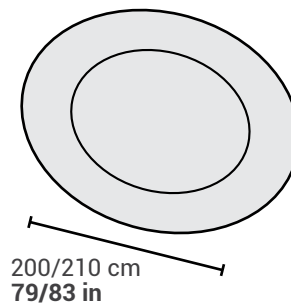

**BUMPER BOAT 1 seat**

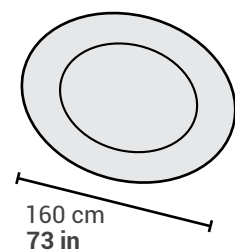



**GALAXY**  
PW5-B700



**FUNNY DUCK**  
PW5-7200



**WILLY**  
PW5-7100



## PRONTI PER NAVIGARE?



**HIPPOCAMPI**  
PW5-7500



**SAIL BARREL** - 1 seat  
PW5-7250



**PIRATE** - 1 seat  
PW5-7150



**BABY SWAN** - 1 seat  
PW5-7350



**WATER CANNON**  
PA4-C900



**WATER CANNON pirate**  
PA4-C904

Vertrieb + Beratung:



[www.rise-consult.de](http://www.rise-consult.de)



# tracks and accessories > EDUCATIONAL



starting grid  
traguardo  
AC950

customized decoration/painting  
for minicar  
colorazioni speciali

Chopper  
PM4-M202



FENCE  
T-ST5001430



BORDER  
T-ST5001410

PC4-C351



charging station  
stazioni di ricarica  
AC957



PA4-C904  
water cannon  
cannone ad acqua



127 cm - 50 in

PA0-2336  
safety stop  
stop di sicurezza

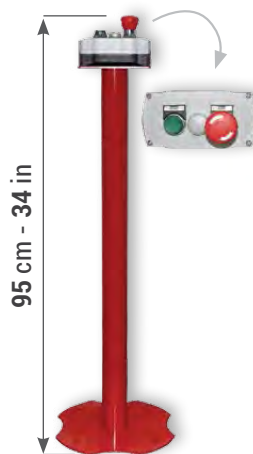

95 cm - 34 in

international roadsigns  
segnali stradali internazionali  
AC953



roadsigns  
segnali stradali  
AC954





rules  
regolamenti

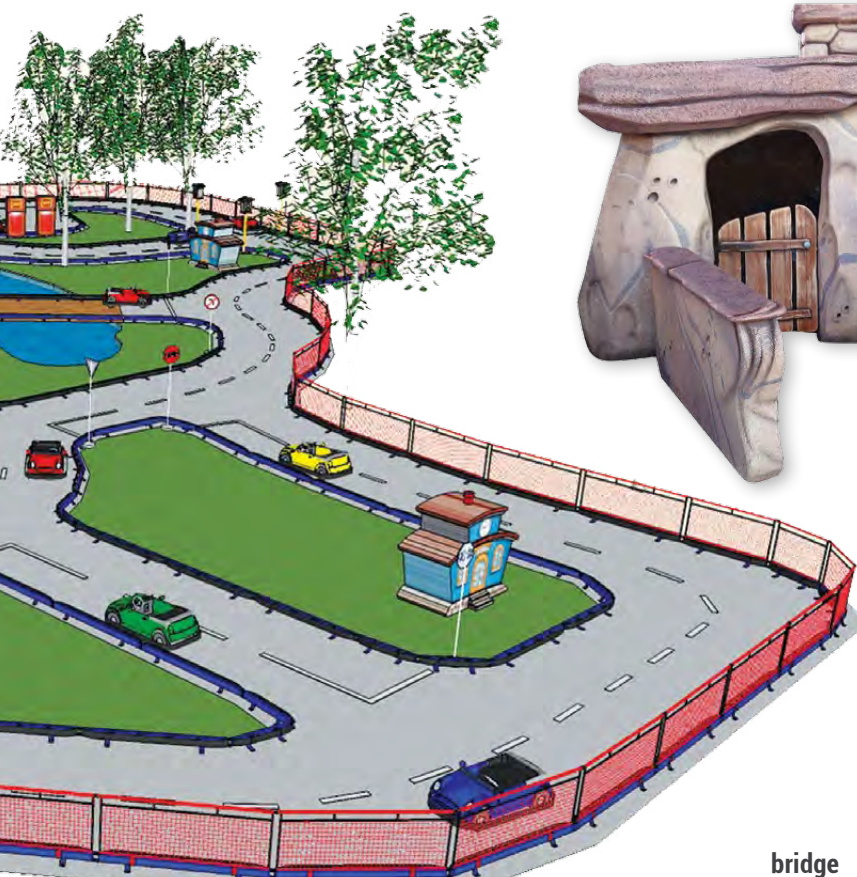

houses  
cassette  
AC958



table, chair and bench  
tavolo, sedie e panchine

AC964

AC961

AC960



bridge  
ponte  
AC961



traffic light  
semaforo  
AC959



racer  
pilota  
AC968

(fiberglass)



mechanic  
meccanico



policeman  
poliziotto  
AC956



Vertrieb + Beratung:  
**RISE**  
www.rise-consult.de



**minicar >**

# EDUCATIONAL 2 seats



**engine - motore**

24V - 408W electric  
max 10 km/h (6 mph)  
direct drive (no belts)  
motoruota  
silent silenzioso  
zero emissions



**coin mech. - gettoniera**

standard token 24 mm  
gettoni 24 mm  
different coins/tokens  
monete/altri gettoni  
drawer with key  
cassetto con chiave

dashboard - cruscotto    reverse gear - retromarcia



2 seat belts  
2 cinture di sicurezza

custom made body



safety sicurezza



horn  
motor/brake sounds  
clacson  
suono motore/freno



lights and turning lights  
luci e frecce



2 seater (1 adult + 1 kid)  
2 posti (adulto+ bambino)

metal plate CE  
targhetta  
identificativa CE



double pedal: accelerator and brake  
doppio pedale: acceleratore e freno

**accessories - accessori**

track border - fences decorations  
bordi pista - ringhiere - decorazioni  
pages 10, 26

remote control - charging station  
safety stop - fuel cap - batteries  
telecomando - stazioni di ricarica  
stop di sicurezza - tappo benzina  
batterie  
page 48

cod. AC 959

we project and realize a  
**real driving school** track  
with police, fire car, school...

creiamo una **vera scuola guida** con la polizia, i vigili del fuoco e i segnali stradali!



**POLICE**  
cod. PC4-C351

**POLICE**  
cod. PM4-M201





### battery - batteria

2x 80Ah or 2x 120Ah AGM  
working time: 4-8 hours  
rechargeable in 6-8 hours  
ricaricabile in 6-8 hours

REMARKS: batteries are sold as accessory (not included)

NB: le batterie sono un accessorio non incluso nel prezzo



### digital timer

easy set up  
regolazione facile  
playing time 30"-999"  
speed, sounds  
n° of token n° di gettoni  
automatic stop



### colours - colori



paintwork on request:  
pirate, jungle, safari...  
verniciature su richiesta:  
pirati, giungla, safari...

age group: 3-99 years  
età: 3-99 anni

engine sounds  
suoni e rumori del motore/freno

simple to operate  
gestione semplice

coordinated decals included  
adesivi inclusi

made in Italy

## CABRIO FOR DRIVING SCHOOL 24V cod. PC4-6360

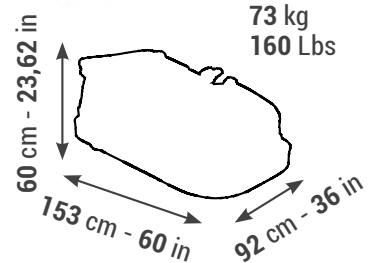

PC4-6360 - red  
rossa



PC4-6360 - black  
nera



PC4-6360 - fire  
vigili del fuoco  
hand painted



## CITY CAR DRIVING SCHOOL 24V cod. PC4-K401



Vertrieb + Beratung:



www.rise-consult.de

# minicar > 2 SEATER



## engine - motore

12V - 310W electric  
max 10 km/h (6 mph)  
direct drive (no belts)  
motoruota  
silent silenzioso  
zero emissions



## coin mech. - gettoniera

standard token 24 mm  
gettoni 24 mm  
different coins/tokens  
monete/altri gettoni  
drawer with key  
cassetto con chiave



socket for battery charger  
presa per caricabatterie



**battery easy change system**  
le batterie si sostituiscono  
velocemente

**charge batteries every night**  
caricare le batterie tutte le sere

coin mechanism  
gettoniera



safety sicurezza



motor/brake sounds  
suono motore/freno

lights - luci



## TIGER PC4-C350



0277  
digital control box  
timer



0617  
battery (not included)



electronic battery charger



metal plate CE  
targhetta identificativa CE



accelerator/electronic brake  
acceleratore/freno elettronico

2 seater (1 adult + 1 kid or 2 kids)  
2 posti (adulto + bambino o 2 bambini)

Vertrieb + Beratung:



www.rise-consult.de



PA1-1594

## accessories - accessori

track border - fences decorations  
bordi pista - ringhiere - decorazioni  
pages 10, 26

remote control - charging station  
safety stop - fuel cap - batteries  
telecomando - stazioni di ricarica  
stop di sicurezza - tappo benzina  
batterie  
page 48





### battery - batteria

1x 80Ah or 1x 120Ah AGM

working time: 4-8 hours

rechargeable in 6-8 hours

ricaricabile in 6-8 hours

REMARKS: batteries are sold as accessory (not included)

NB: le batterie sono un accessorio non incluso nel prezzo



### digital timer

easy set up

regolazione facile

playing time 30"-999"

speed, sounds

n° of token n° di gettoni

electronic brake

freno elettronico

automatic stop



### colours - colori



paintwork on request:

pirate, jungle, safari...

verniciature su richiesta:

pirati, giungla, safari...

age group: 3-99 years

età: 3-99 anni

engine sounds

suoni e rumori del motore/freno

simple to operate

gestione semplice

coordinated decals included

adesivi inclusi

made in Italy

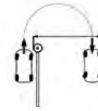

turning circle  
raggio di sterzata

125 cm

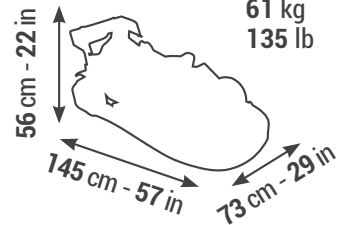

61 kg  
135 lb

## FORMULA 1 V-P

cod. PC4-6009



## FORMULA 1 V-MAX

cod. PC4-C100



/YO



/R



/BG



/WB



/WR



/GR



/VY



Vertrieb + Beratung:



www.rise-consult.de

# minicar > 2 SEATER



## engine - motore

12V - 310W electric  
max 10 km/h (6 mph)  
direct drive (no belts)  
motoruota  
silent - silenzioso  
zero emissions



## coin mech. - gettoniera

standard token 24 mm  
gettoni 24 mm  
different coins/tokens  
monete/altri gettoni  
drawer with key  
cassetto con chiave

### OUR FACTORY - LA PRODUZIONE



## MINI GO KART 12V cod. PC4-C301



turning circle  
raggio di sterzata  
224 cm

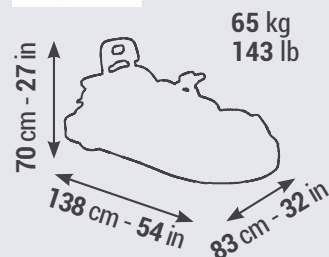

Vertrieb + Beratung:

**RISE**

www.rise-consult.de





### battery - batteria

1x 80Ah or 1x 120Ah AGM  
working time: 4-8 hours  
rechargeable in 6-8 hours  
ricaricabile in 6-8 hours

REMARKS: batteries are sold as accessory (not included)

NB: le batterie sono un accessorio non incluso nel prezzo



### digital timer

easy set up  
regolazione facile  
playing time 30"-999"  
speed, sounds  
n° of token n° di gettoni  
electronic brake  
freno elettronico  
automatic stop



### colours - colori



paintwork on request:  
pirate, jungle, safari...  
verniciature su richiesta:  
pirati, giungla, safari...

age group: 3-99 years  
età: 3-99 anni

engine sounds  
suoni e rumori del motore/freno

simple to operate  
gestione semplice

coordinated decals included  
adesivi inclusi

made in Italy

## TWIN cod. PC4-6950

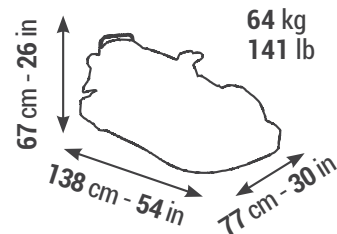

PC4-6950  
orange

## TWIN SPACE cod. PC4-6970

checkered flag  
scacchi  
Hand painted

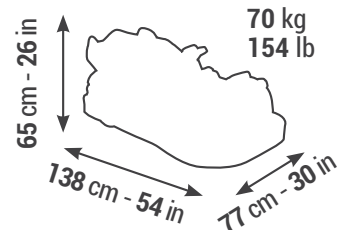

PC4-6970  
red/blue  
rosso blu



PC4-6970  
blue night

Vertrieb + Beratung:



www.rise-consult.de



# minicar > 2 SEATS



**engine - motore**

12V - 310W electric  
max 10 km/h (6 mph)  
direct drive (no belts)  
motoruota  
silent silenzioso  
zero emissions



**coin mech. - gettoniera**

standard token 24 mm  
gettoni 24 mm  
different coins/tokens  
monete/altri gettoni  
drawer with key  
cassetto con chiave

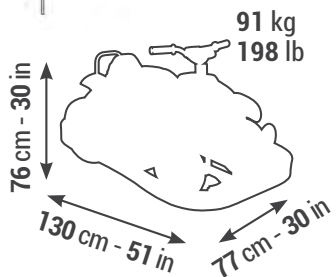
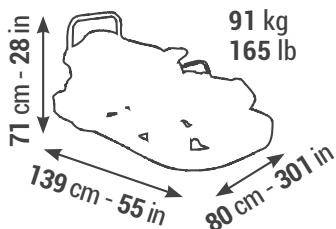

**EUROQUAD 2012**  
cod. PC4-C351



police





### battery - batteria

1x 80Ah or 1x 120Ah AGM  
working time: 4-8 hours  
rechargeable in 6-8 hours  
ricaricabile in 6-8 hours

REMARKS: batteries are sold as  
accessory (not included)

NB: le batterie sono un accessorio  
non incluso nel prezzo



### digital timer

easy set up  
regolazione facile  
playing time 30"-999"  
speed, sounds  
n° of token n° di gettoni  
electronic brake  
freno elettronico  
automatic stop



### colours - colori



paintwork on request:  
pirate, jungle, safari...  
verniciature su richiesta:  
pirati, giungla, safari...

age group: 3-99 years  
età: 3-99 anni

engine sounds  
suoni e rumori del motore/freno

simple to operate  
gestione semplice

coordinated decals included  
adesivi inclusi

made in Italy

## OFF ROAD

cod. PC4-C350



paintwork on request  
verniciatura su richiesta



PC4-C350  
green  
verde

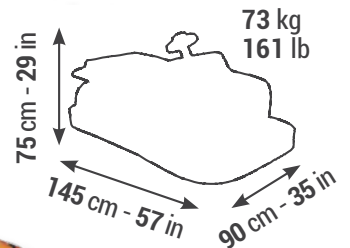
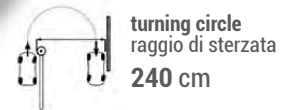

PC4-C350  
dinosaur



PC4-C350  
tiger



PC4-C350  
pirate



PC4-C350  
jungle



Vertrieb + Beratung:



# minicar > 2 SEATS



## engine - motore

12V - 310W electric  
max 10 km/h (6 mph)  
direct drive (no belts)  
motoruota  
silent silenzioso  
zero emissions



## coin mech. - gettoniera

standard token 24 mm  
gettoni 24 mm  
different coins/tokens  
monete/altri gettoni  
drawer with key  
cassetto con chiave



turning circle  
raggio di sterzata  
275 cm

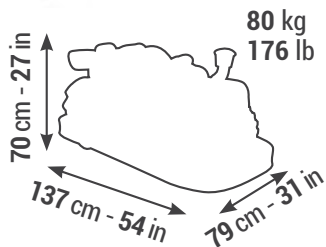

## FARM TRACTOR

cod. PC4-6460

Hand painted



turning circle  
raggio di sterzata  
215 cm

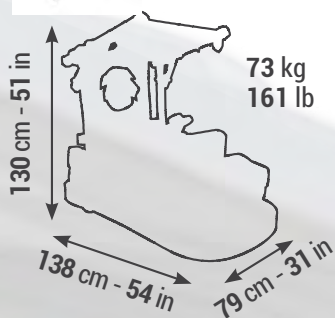

## FLINT MOBILE

cod. PC4-C300

Customized

TM & © Hanna-Barbera (s11)  
Licensed by Dedem



Vertrieb + Beratung:

**RISE**

www.rise-consult.de



### battery - batteria

1-2 x 80Ah or 1-2 x 120Ah AGM  
**working time:** 4-8 hours  
**rechargeable in 6-8 hours**  
 ricaricabile in 6-8 hours  
**REMARKS:** batteries are sold as accessory (not included)  
 NB: le batterie sono un accessorio non incluso nel prezzo



### digital timer

**easy set up**  
 regolazione facile  
**playing time 30"-999"**  
**speed, sounds**  
 n° of token n° di gettoni  
**electronic brake**  
 freno elettronico  
**automatic stop**



### colours - colori



**paintwork on request:**  
 pirate, jungle, safari...  
**verniciature su richiesta:**  
 pirati, giungla, safari...

**age group: 3-99 years**  
 età: 3-99 anni

**engine sounds**  
 suoni e rumori del motore/freno

**simple to operate**  
 gestione semplice

**coordinated decals included**  
 adesivi inclusi

**made in Italy**

## CABRIO RACING - 24V

cod. PC4-6350

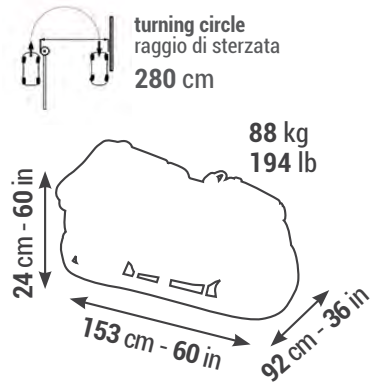

cod. PC4-6350  
cabrio safari



cod. PC4-6350  
cabrio emirates



## CITY CAR - 24V

cod. PC4-K400



cod. PC4-6350  
paintwork on request  
verniciatura su richiesta



Vertrieb + Beratung:  
  
[www.rise-consult.de](http://www.rise-consult.de)





**engine - motore**

12V - 310W electric  
max 10 km/h (6 mph)  
direct drive (no belts)  
motoruota  
silent silenzioso  
zero emissions



**coin mech. - gettoniera**

standard token 24 mm  
gettoni 24 mm  
different coins/tokens  
monete/altri gettoni  
drawer with key  
cassetto con chiave



turning circle  
raggio di sterzata  
175 cm

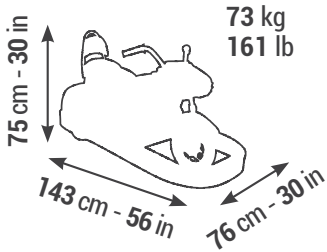

cod. PM4-6550  
fuxia



## TRIKE cod. PM4-6550

lilla

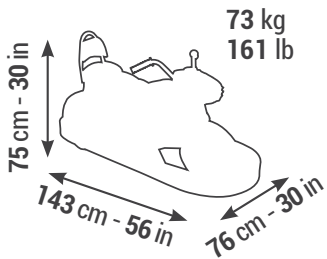

cod. PM4-M202  
red



## CHOPPER cod. PM4-M202

cod. PM4-M202  
fire



Vertrieb + Beratung:

**RISE**

www.rise-consult.de



### battery - batteria

1x 80Ah or 1x 120Ah AGM  
working time: 4-8 hours  
rechargeable in 6-8 hours  
ricaricabile in 6-8 hours

REMARKS: batteries are sold as  
accessory (not included)

NB: le batterie sono un accessorio  
non incluso nel prezzo



### digital timer

easy set up  
regolazione facile  
playing time 30"-999"  
speed, sounds  
n° of token n° di gettoni  
electronic brake  
freno elettronico  
automatic stop



### colours - colori



paintwork on request:  
pirate, jungle, safari...  
verniciature su richiesta:  
pirati, giungla, safari...

age group: 3-99 years  
età: 3-99 anni

engine sounds  
suoni e rumori del motore/freno

simple to operate  
gestione semplice

coordinated decals included  
adesivi inclusi

made in Italy

## SUPER BIKE

cod. PM4-M200

hand painted

blue flash

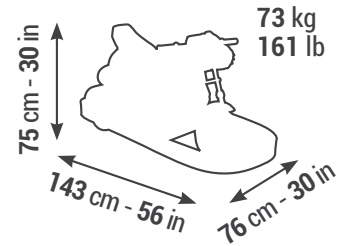

cod. PM4-M200

checkered flag  
scacchi



cod. PM4-M200

Thunderbolt  
fiamme verde



cod. PM4-M200

blue-red

## SPORTING

cod. PM4-6750

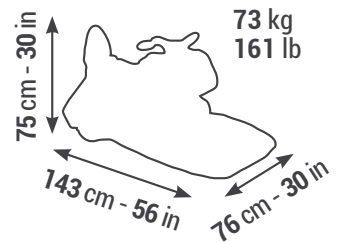

Vertrieb + Beratung:



[www.rise-consult.de](http://www.rise-consult.de)





12V - 310W electric  
max 10 km/h (6 mph)  
direct drive (no belts)  
motoruota  
silent silenzioso  
zero emissions



standard token 24 mm  
gettoni 24 mm  
different coins/tokens  
monete/altri gettoni  
drawer with key  
cassetto con chiave



turning circle  
raggio di sterzata  
175 cm

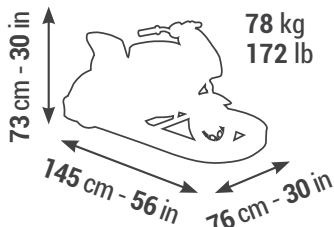

cod. PM4-6650



blue  
blu



cod. PM4-6650

yellow  
giallo

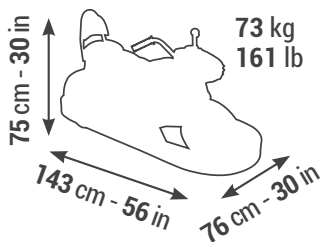

black  
nera

cod. PM4-M201

**GP**

cod. PM4-6650

red  
rosso



**POLICE**

cod. PM4-M201

light blue/white  
azzurro/bianco



also available in:   
green/white   
red/white   
blue/white

disponibile anche in:   
verde/bianco   
rosso/bianco   
blu/bianco

Vertrieb + Beratung:



www.rise-consult.de





### battery - batteria

1x 80Ah or 1x 120Ah AGM  
working time: 4-8 hours  
rechargeable in 6-8 hours  
ricaricabile in 6-8 hours

**REMARKS: batteries are sold as accessory (not included)**

NB: le batterie sono un accessorio non incluso nel prezzo



### digital timer

easy set up  
regolazione facile  
playing time 30"-999"  
speed, sounds  
n° of token n° di gettoni  
electronic brake  
freno elettronico  
automatic stop



### colours - colori



paintwork on request:  
pirate, jungle, safari...  
verniciature su richiesta:  
pirati, giungla, safari...

age group: 3-99 years  
età: 3-99 anni

engine sounds  
suoni e rumori del motore/freno

simple to operate  
gestione semplice

coordinated decals included  
adesivi inclusi

made in Italy



Vertrieb + Beratung:

**RISE**  
www.rise-consult.de

# TRACKS FOR MINICAR

## PISTE per MINICAR

Vertrieb + Beratung:



Floor: industrial flat concrete.  
You can also use asphalt.

Example of track border and number of mini cars that can run.

We project best **track solution**, taking into consideration available space and wished number of mini cars.

40' x 20' for 4 - 5 minicar

49' x 30' for 8 - 10 minicar

66' x 33' for 10 - 12 minicar



Pavimento consigliato: cemento lucido industriale. In alternativa si può utilizzare un pavimento in asfalto.

Esempi di **dimensioni di piste** e quantità di macchinine utilizzabili.

Progettiamo le migliori soluzioni per la vostra pista, considerando lo spazio disponibile ed al numero di mini car.

12 x 6m - 40' x 20' per 4 - 5 minicar

15 x 9m - 49' x 30' per 7 - 8 minicar

20 x 10m - 66' x 33' per 10 - 12 minicar



SETTINGS ON REQUEST  
SCENOGRAFIE A RICHIESTA

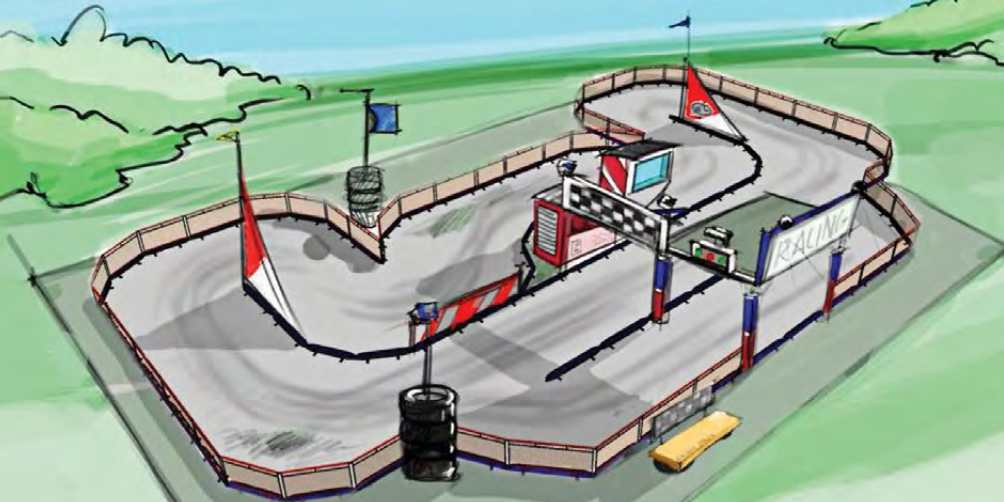

# EASY BORDER and FENCES

## BORDI PISTA e RINGHIERE



### EASY BORDER - BORDO PISTA

- |   |                  |                         |
|---|------------------|-------------------------|
| L | - 100 cm - 39 in | <b>cod. T-STA001409</b> |
|   | - 150 cm - 59 in | <b>cod. T-STA001408</b> |
|   | - 200 cm - 79 in | <b>cod. T-STA001410</b> |

### CENTRAL BORDER - SPARTITRAFFICO

- |   |                  |                         |
|---|------------------|-------------------------|
| L | - 100 cm - 39 in | <b>cod. T-STA001412</b> |
|   | - 150 cm - 59 in | <b>cod. T-STA001413</b> |
|   | - 200 cm - 79 in | <b>cod. T-STA001411</b> |

### RAILING - RINGHIERA

- |   |                  |                         |
|---|------------------|-------------------------|
| L | - 100 cm - 39 in | <b>cod. T-STS001425</b> |
|   | - 150 cm - 59 in | <b>cod. T-STS001417</b> |
|   | - 200 cm - 79 in | <b>cod. T-STS001430</b> |

**WE PROJECT YOUR NEXT TRACK!**  
**PROGETTIAMO LA VOSTRA PISTA!**



# minicar > 1 SEAT



## engine - motore

12V - 200W electric  
max 10 km/h (6 mph)  
direct drive (no belts)  
motoruota  
silent silenzioso  
zero emissions



## coin mech. - gettoniera

standard token 24 mm  
gettoni 24 mm  
different coins/tokens  
monete/altri gettoni  
drawer with key  
cassetto con chiave



turning circle  
raggio di sterzata  
140 cm

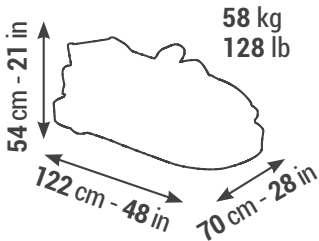

**RALLY**  
cod. PC4-6006



pink  
rosa



**SPORT**  
cod. PC4-6200



light blue



**X3**  
cod. PC4-6250  
hand painted



Vertrieb + Beratung:

**RISE**

www.rise-consult.de

\* paintwork on request  
verniciatura su richiesta



### battery - batteria

1x 80Ah or 1x 120Ah AGM  
working time: 4-8 hours  
rechargeable in 6-8 hours  
ricaricabile in 6-8 hours

REMARKS: batteries are sold as  
accessory (not included)

NB: le batterie sono un accessorio  
non incluso nel prezzo



### digital timer

easy set up  
regolazione facile  
playing time 30"-999"  
speed, sounds  
n° of token n° di gettoni  
electronic brake  
freno elettronico  
automatic stop



### colours - colori



paintwork on request:  
pirate, jungle, safari...  
verniciature su richiesta:  
pirati, giungla, safari...

age group: 3-99 years  
età: 3-99 anni

engine sounds  
suoni e rumori del motore/freno

simple to operate  
gestione semplice

coordinated decals included  
adesivi inclusi

made in Italy

## MINI OFF ROAD cod. PC4-C150

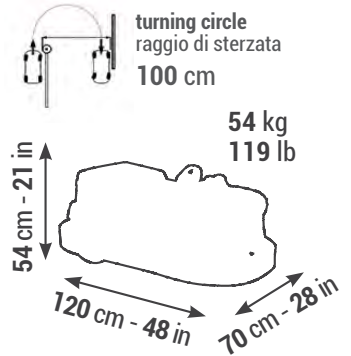

## MINI FORMULA 1 cod. PC4-C151

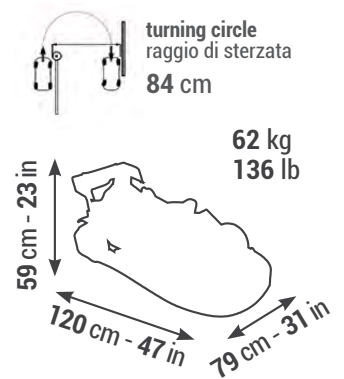

Vertrieb + Beratung:



# go kart > 1/2 SEATER



## engine - motore

24V - 780W electric  
max 20 km/h (12 mph)  
direct drive (no belts)  
motoruota  
silent silenzioso  
zero emissions



## coin mech. - gettoniera

standard token 24 mm  
gettoni 24 mm  
different coins/tokens  
monete/altri gettoni  
drawer with key  
cassetto con chiave

## GO KART DOUBLE 2 seater - 24 V cod. PK4-6850



**easy change system**  
le batterie si sostituiscono  
velocemente

**charge batteries every night**  
caricare le batterie tutte le sere



**socket for battery charger**  
presa per caricabatterie



**motor/brake sounds**  
suono motore/freno

**seat belt**  
cintura di sicurezza



**coin mechanism**  
gettoniera



**accelerator - brake**  
acceleratore - freno

2 seater (1 adult + 1 kid)  
2 posti (adulto+ bambino)

### accessories - accessori

**track border - fences decorations**  
bordi pista - ringhiere - decorazioni  
pages 10, 26

**remote control - charging station**  
**safety stop - fuel cap - batteries**  
telecomando - stazioni di ricarica  
stop di sicurezza - tappo benzina  
batterie  
page 48



Vertrieb + Beratung:  
**RISE**  
www.rise-consult.de





### battery - batteria

2 x 80Ah or 2 x 120Ah AGM  
 working time: 4-8 hours  
 rechargeable in 6-8 hours  
 ricaricabile in 6-8 hours

**REMARKS: batteries are sold as accessory (not included)**

NB: le batterie sono un accessorio non incluso nel prezzo



### digital timer

easy set up  
 regolazione facile  
 playing time 30"-999"  
 speed, sounds  
 n° of token n° di gettoni  
 automatic stop



### colours - colori



paintwork on request:  
 pirate, jungle, safari...  
 verniciature su richiesta:  
 pirati, giungla, safari...

age group: 6-99 years  
 età: 6-99 anni

engine sounds  
 suoni e rumori del motore/freno

simple to operate  
 gestione semplice

coordinated decals included  
 adesivi inclusi

 made in Italy



turning circle  
 raggio di sterzata  
 300 cm

## GO KART 24 V - 1 seat

cod. PK4-6800

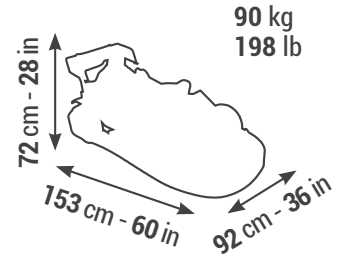

# big car > 2 SEATER



## engine - motore

12V - 800W electric  
max 18 km/h (10 mph)  
direct drive (no belts)  
motoruota  
silent silenzioso  
zero emissions



## coin mech. - gettoniera

standard token 24 mm  
gettoni 24 mm  
different coins/tokens  
monete/altri gettoni  
drawer with key  
cassetto con chiave



socket for battery charger  
presa per caricabatterie

### easy change system

le batterie si sostituiscono  
velocemente

### charge batteries every night

caricare le batterie tutte le sere



### engine sounds

clacson - suoni  
di motore/freno

## CALIFORNIA

cod. PG4-6300

### lights - luci



coin mechanism  
gettoniera

metal plate CE  
targhetta identificativa CE



accelerator - disc brake  
acceleratore - freno a disco

2 seater (1 adult + 1 kid)  
2 posti (adulto + bambino)

### accessories - accessori

track border - fences decorations  
bordi pista - ringhiere - decorazioni  
pages 10, 26

remote control - charging station  
safety stop - fuel cap - batteries  
telecomando - stazioni di ricarica  
stop di sicurezza - tappo benzina  
batterie  
page 48



Vertrieb + Beratung:

**RISE**

www.rise-consult.de







### batteries - batterie

2 x 120Ah AGM  
working time: 4-8 hours  
rechargeable in 6-8 hours  
ricaricabile in 6-8 hours

REMARKS: batteries are sold as accessory (not included)

NB: le batterie sono un accessorio non incluso nel prezzo



### digital timer

easy set up  
regolazione facile  
playing time 30"-999"  
speed, music  
n° of token n° di gettoni



### colours - colori



paintwork on request:  
pirate, jungle, safari...  
verniciature su richiesta:  
pirati, giungla, safari...

age group: 8-99 years  
età: 8-99 anni  
engine sounds  
suoni e rumori di strada  
simple to operate  
gestione semplice

made in Italy

## SAFARI cod. PG4-6100



## LIBERTY cod. PC4-K450



80 kg  
176 lb

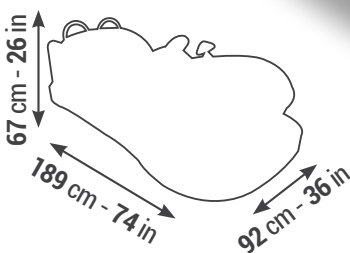

Vertrieb + Beratung:



[www.rise-consult.de](http://www.rise-consult.de)



# bumper car > 2 SEATER



**engine - motore**

2 x 24V - 408W electric  
max 10 km/h (6 mph)  
direct drive (no belts)  
motoruota  
silent silenzioso  
zero emissions



**coin mech. - gettoniera**

standard token 24 mm  
gettoni 24 mm  
different coins/tokens  
monete/altri gettoni  
drawer with key  
cassetto con chiave

display



**socket for battery charger**  
presa per caricabatterie

**easy change system**  
le batterie si sostituiscono  
velocemente

**charge batteries every night**  
caricare le batterie tutte le sere

**track borders without floor**  
bordo pista senza pavimento



track 9 x 9 is suitable for 5/6 bumper car  
track 10,5 x 10,5 is suitable for 8/10 bumper car

**2 joysticks: forward  
backwards - turns**  
avanti - indietro - giro



**music - musica**

**3 targets  
on 2 sides 1 front**  
3 bersagli:  
nei 2 lati  
e nel fronte

**security sicurezza**



**HYPER BUMPER**

Hand painted

**digital control box  
timer**



**accessories - accessori**

**track border - fences decorations**  
bordi pista - ringhiere - decorazioni  
pages 10, 26

**charging station - batteries  
sparepart kit**  
stazioni di ricarica - batterie  
kit ricambi  
page 48

**2 seater (1 adult + 1 kid)**  
2 posti (adulto+ bambino)



Vertrieb + Beratung:  
**RISE**  
www.rise-consult.de





### batteries - batterie

2 x 80Ah or 2 x 120Ah AGM  
 working time: 4-8 hours  
 rechargeable in 6-8 hours  
 ricaricabile in 6-8 hours  
**REMARKS: batteries are sold as accessory (not included)**  
 NB: le batterie sono un accessorio non incluso nel prezzo



### digital timer

easy set up  
 regolazione facile  
 playing time 30"-999"  
 speed, music  
 n° of token  
 n° di gettoni



### colours - colori

paintwork on request:  
 ice, space, spacecraft,  
 pirate, jungle, safari...  
 verniciature su richiesta:  
 ghiaccio, navicella spaziale,  
 pirati, giungla, safari...

age group: 6-99 years  
 età: 6-99 anni  
 music and sounds  
 musica e suoni  
 simple to operate  
 gestione semplice  
 coordinated decals included  
 adesivi inclusi  
 made in Italy



screen 42" - schermo 42"  
 bumper car shoot & spin



## HYPER BUMPER Score Screen

cod. AC969 outdoor  
 cod. AC970 indoor

**Remote Controller**  
 cod. EX0-2452



Simple Start and Stop function

**Remote Controller**  
 cod. M-CE001669



Advanced multifunction controller



### Game Play Control

Simple to operate  
 Easy setup  
 Players on screen: 2 - 9  
 Playing time: 30" - 990"  
 Score record: 0 - 99  
 for free ride to the winner



### Wireless Control

Wireless 2.4Ghz system  
 on Score Screen controller  
 on Bumper Cars  
 on Remote controllers  
 Very long range capability  
 Interferences immunity



### Sound

Optional: Sound capability  
 Embedded stereo amplifier  
 External amplifier line output



### Universal Power

Voltage: 100 - 240 vac  
 Frequency: 50 / 60 Hz

\* paintwork on request  
 vernicatura con sovrapprezzo



When bumper is hit, it spins 360°  
 Quando il bumper viene colpito  
 ruota su se stesso

Professional 42" LCD screen  
 Waterproof Outdoor version  
 available



<http://eurogames.it>

Vertrieb + Beratung:



[www.rise-consult.de](http://www.rise-consult.de) 35

# bumper car



**engine - motore**

2 x 24V - 408W electric  
max 10 km/h (6 mph)  
direct drive (no belts)  
motoruota  
silent silenzioso  
zero emissions



**coin mech. - gettoniera**

standard token 24 mm  
gettoni 24 mm  
different coins/tokens  
monete/altri gettoni  
drawer with key  
cassetto con chiave

**MINI BUMPER CAR**  
cod. PB5-B550



cod. PB5-B550  
Hand painted



82 kg  
180 lb

105 cm - 41 in



Ø 120 cm - 47 in

**INDOOR - OUTDOOR**  
**CONCRETE - WOOD - REAL ICE - SYNTHETIC ICE**  
**CEMENTO - ASFALTO - LEGNO - GHIACCIO VERO - GHIACCIO SINTETICO**



LED Strip for special effect



Tokens container



Special Joysticks with  
Fire effect buttons



Panel with backlight

**FUN FOR KID, TEENAGERS, ADULTS**  
**DIVERTIMENTO PER BAMBINI, TEENAGER E ADULTI**



Vertrieb + Beratung:

**RISE**  
www.rise-consult.de

**batteries - batterie**

2 x 80Ah or 2 x 120Ah AGM  
 working time: 4-8 hours  
 rechargeable in 6-8 hours  
 ricaricabile in 6-8 hours

**REMARKS: batteries are sold as accessory (not included)**

NB: le batterie sono un accessorio non incluso nel prezzo

**digital timer**

easy set up  
 regolazione facile  
 playing time 30"-999"  
 speed, music  
 n° of token n° di gettoni

**colours - colori**

5 standard colours  
 5 colori standard

age group: 6-99 years

età: 6-99 anni

music and sounds

musica e suoni

simple to operate

gestione semplice

coordinated decals included

adesivi inclusi

 made in Italy

**BUMPER CAR**  
**cod. PB5-B500**  
**Hand painted**



**BUMPER CAR ICE**  
**cod. PB5-B501**  
**ideal for ICE tracks**  
**ideale per piste GHIACCIO**

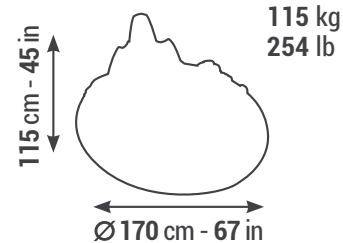

remote control  
 telecomando  
**START & STOP**  
 cod. EX0-2452

Red



1

2



STANDARD COLOURS

5



Grey

Blue



3

4



Yellow



space/ice bumper  
 trolley  
 carrello  
 space/ice bumper  
 cod. M-STA001574

track with floor - bordo pista con pavimento



Vertrieb + Beratung:



www.rise-consult.de

# bumper boat

## > 2 SEATER



**engine - motore**

24V  
870W electric internal motor  
300W electric exterior motor  
max 8 km/h (6 mph)  
silent silenzioso  
zero emissions



**coin mech. - gettoniera**

standard token 24 mm  
gettoni 24 mm  
on request:  
different coins/tokens  
su richiesta:  
monete/altri gettoni  
drawer with key  
cassetto con chiave

**Pirate**

Cod. PW5-B703

Hand painted



**coin mechanism**  
gettoniera



**accelerator**  
acceleratore



**music - musica**



25 cm - 0,82 ft



**socket for battery charger**  
presa per caricabatterie



**water distance - getto**  
4 m - 13 ft

**internal motor**  
motore interno



**minimum water depth**  
profondità minima  
dell'acqua  
50 cm - 2 ft

**outside propeller**  
elica esterna



**metal plate CE**  
targhetta  
identificativa CE

**2 seater (1 adult + 1 kid)**  
2 posti (adulto+ bambino)

### Accessories

### Accessori

**pool - decorations - water cannon**  
piscina - scenografia - cannoncino  
pages 46-47

**remote control - charging station**  
safety stop - tokens - spare part kit  
batteries  
telecomando - stazioni di ricarica  
stop di sicurezza - gettoni - kit  
ricambi - batterie  
page 48



Vertrieb + Beratung:



www.rise-consult.de





### batteries - batterie

2x 80Ah or 2x 120Ah AGM  
 working time: 4-8 hours  
 rechargeable in 6-8 hours  
 ricaricabile in 6-8 hours  
**REMARKS: batteries are sold as accessory (not included)**  
 NB: le batterie sono un accessorio non incluso nel prezzo



### digital timer

easy set up  
 regolazione facile  
 playing time 30"-999"  
 speed, music  
 n° of token n° di gettoni



### colours - colori



paintwork on request:  
 pirate, jungle, safari...  
 verniciature su richiesta:  
 pirati, giungla, safari...

age group: 3-99 years  
 età: 3-99 anni

music and sounds  
 musica e suoni

simple to operate  
 gestione semplice

coordinated decals included  
 adesivi inclusi

made in Italy

## SPLASH

cod. PW5-B702

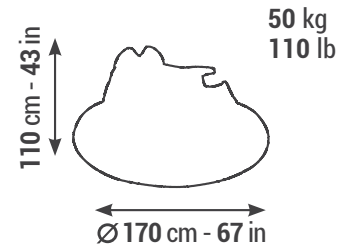

## SPLASH with water cannon

cod. PW5-B701

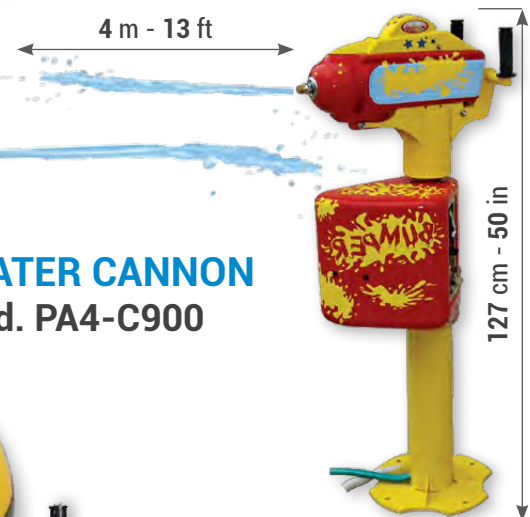

## WATER CANNON

cod. PA4-C900



## WATER CANNON pirate

cod. PA4-C904

# bumper boat

## > 2 SEATER



**engine - motore**

24V - 300W electric  
max 8 km/h (6 mph)  
silent silenzioso  
zero emissions



**coin mech. - gettoniera**

standard token 24 mm  
gettoni 24 mm  
different coins/tokens  
monete/altri gettoni  
drawer with key  
cassetto con chiave

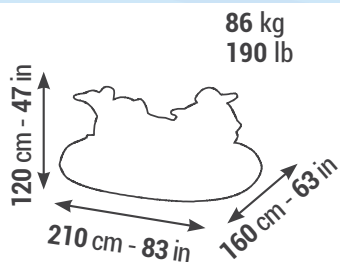

**WILLY**  
cod. PW5-7100



**DOLPHINS**  
cod. PW5-7600

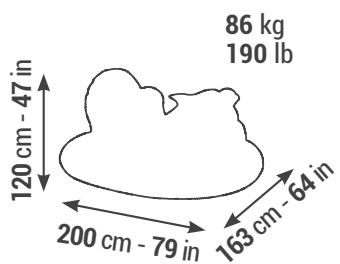

Vertrieb + Beratung:

**RISE**  
www.rise-consult.de







### battery - batteria

2x 80Ah or 2x 120Ah AGM  
working time: 4-8 hours  
rechargeable in 6-8 hours  
ricaricabile in 6-8 hours

**REMARKS: batteries are sold as accessory (not included)**

NB: le batterie sono un accessorio non incluso nel prezzo



### digital timer

easy set up  
regolazione facile  
playing time 30"-999"  
speed, music  
n° of token n° di gettoni



### colours - colori



paintwork on request:  
pirate, jungle, safari...  
verniciature su richiesta:  
pirati, giungla, safari...

age group: 3-99 years  
età: 3-99 anni

music and sounds  
musica e suoni

simple to operate  
gestione semplice

coordinated decals included  
adesivi inclusi

made in Italy

## CRAZY POLYP cod. PW5-7400

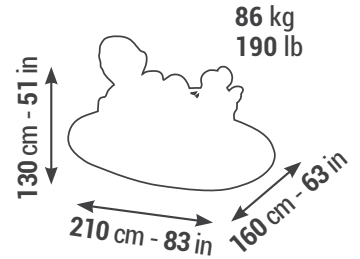

### WATERCANNON

on request

CANNONCINO ad acqua  
su richiesta



Vertrieb + Beratung:



www.rise-consult.de

# bumper boat

## > 2 SEATER



**engine - motore**

24V - 300W electric  
max 10 km/h (6 mph)  
silent silenzioso  
zero emissions



**coin mech. - gettoniera**

standard token 24 mm  
gettoni 24 mm  
different coins/tokens  
monete/altri gettoni  
drawer with key  
cassetto con chiave

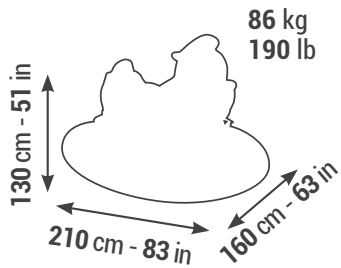

**FUNNY DUCK**  
cod. PW5-7200

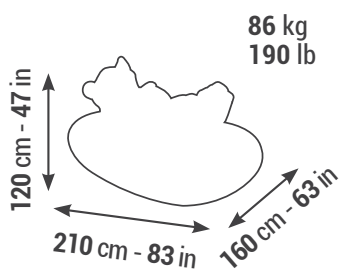

**HAPPY BEAR**  
cod. PW5-7300



Vertrieb + Beratung:

**RISE**

[www.rise-consult.de](http://www.rise-consult.de)



**battery - batteria**

2x 80Ah or 2x 120Ah AGM  
 working time: 4-8 hours  
 rechargeable in 6-8 hours  
 ricaricabile in 6-8 hours

**digital timer**

easy set up  
 regolazione facile  
 playing time 30"-999"  
 speed, music  
 n° of token n° di gettoni

**colours - colori**

age group: 3-99 years  
 età: 3-99 anni  
 music and sounds  
 musica e suoni  
 simple to operate  
 gestione semplice  
 made in Italy

**FROG**

cod. PW5-7800

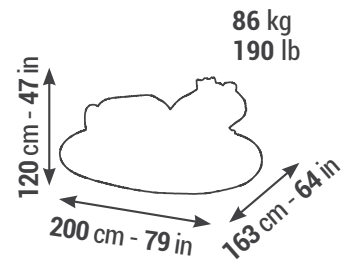
**HIPPOCAMPI**

cod. PW5-7500

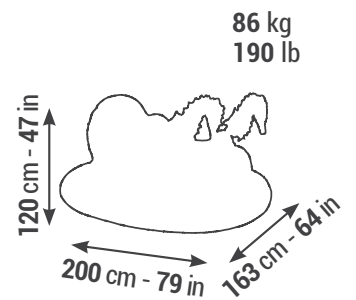

Vertrieb + Beratung:



# bumper boat

## > 2 SEATER



**engine - motore**

24V - 300W electric  
max 8 km/h (6 mph)  
silent silenzioso  
zero emissions



**coin mech. - gettoniera**

standard token 24 mm  
gettoni 24 mm  
different coins/tokens  
monete/altri gettoni  
drawer with key  
cassetto con chiave

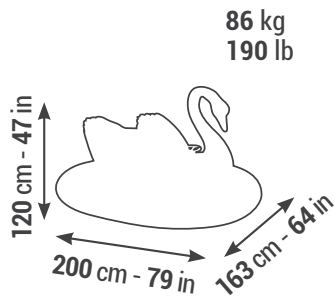

86 kg  
190 lb

**SWAN**  
cod. PW5-7700

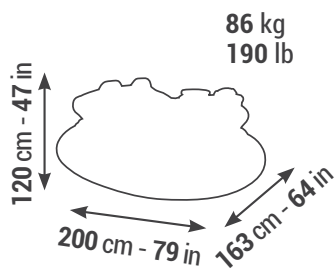

86 kg  
190 lb

**GALAXY**  
cod. PW5-B700



Vertrieb + Beratung:  
**RISE**  
www.rise-consult.de

**battery - batteria**

1x 80Ah or 1x 120Ah AGM  
 working time: 4-8 hours  
 rechargeable in 6-8 hours  
 ricaricabile in 6-8 hours

**digital timer**

easy set up  
 regolazione facile  
 playing time 30"-999"  
 speed, music  
 n° of token n° di gettoni  
 electronic brake  
 freno elettronico

**colours - colori**

paintwork on request:  
 pirate, jungle, safari...  
 verniciature su richiesta:  
 pirati, giungla, safari...

age group: 3-10 years (max xx lb)  
 età: 3-10 anni (max 40 kg)  
 music and sounds  
 musica e suoni  
 simple to operate  
 gestione semplice  
 coordinated decals included  
 adesivi inclusi  
 made in Italy



**PIRATE**  
 1 seat  
 cod. PW5-7150

**engine - motore**

12V - 300W electric  
 max 8 km/h (6 mph)

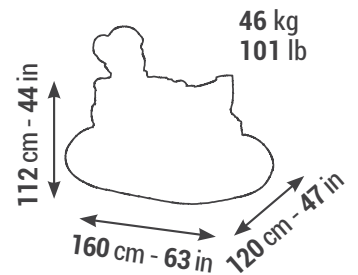

**BABY SWAN**  
 1 seat  
 cod. PW5-7350

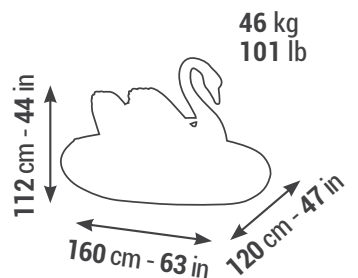

**SAIL BARREL**  
 1 seat  
 cod. PW5-7250

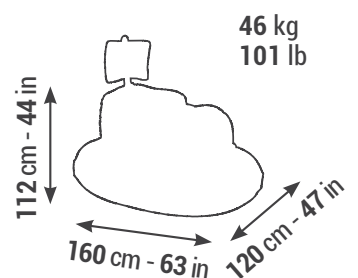

Vertrieb + Beratung:  
  
 www.rise-consult.de



# BUMPER POOL PISCINA

Vertrieb + Beratung:

**RISE**

www.rise-consult.de

Bumper Boat pool is built with modular units and **it can easily adapt to your space needs**. Basic version can be equipped with many accessories as shown on the next page. Decorations and scenery will bring out a special attraction!

**STANDARD DIMENSIONS** are:

12 x 6 m for 4 - 5 bumper boats  
16 x 8 m for 7 - 8 bumper boats  
20 x 10 m for 10 - 12 bumper boats

Other dimensions on request

La piscina per bumper boat è costruita in **moduli componibili**, in grado di adattarsi a qualsiasi esigenza.

Le **DIMENSIONI STANDARD** sono:

12 x 6 m per 4 - 5 bumper boats  
16 x 8 m per 7 - 8 bumper boats  
20 x 10 m per 10 - 12 bumper boats

Altre dimensioni su richiesta.



**SETTINGS ON REQUEST**  
**SCENOGRAFIE A RICHIESTA**



# OPTIONAL for POOL ACCESSORI PISCINA

Vertrieb + Beratung:

**RISE**

www.rise-consult.de

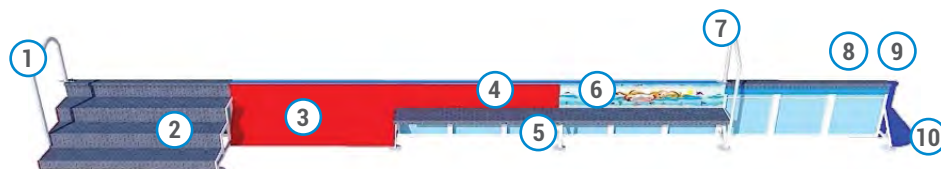

- ① staircase docking handrail - tubo attracco scala
- ② 200 cm aluminium three-step staircase - scala tre gradini in alluminio cm 200
- ③ pool leg-cover decorated 200 cm panel - pannello decorativo copripiede cm 200
- ④ platform decorated 200 cm panel - pannello decorativo sopra pedana cm 200
- ⑤ 200 cm platform - pedana cm 200
- ⑥ platform decorated 200 cm. panel with stickers  
pannello decorativo con adesivo sopra pedana cm 200
- ⑦ platform docking handrail - tubo attracco pedana
- ⑧ 200 cm aluminium edge cover (necessary with staircase or with decorated panels)  
copribordo in alluminio cm. 200 (necessario con scala o con pannello decorativo)
- ⑨ 200 cm aluminium edge cover anti-splash - copribordo in alluminio cm 200 antispruzzo
- ⑩ fiberglass pool corner - angolo piscina in resina
- ⑪ water filter: sand filter, self cleaning filter, 220V pump, valve to empty pool  
depuratore: filtraggio a sabbia, lavaggio filtro automatico, pompa 220V, valvola scarico piscina.



# REMOTE CONTROL - ACCESSORIES

## TELECOMANDO - ACCESSORI



### MULTIFUNCTION - MULTIFUNZIONE

for minicar and bumper boat - per minicar e bumper boat

cod. M-CE001669

Allows complete control of all settings, such as:

- volume
- number of tokens/coins
- speed and braking time
- start & stop - pause
- playing time

Permette il controllo a distanza di tutte le funzioni delle mini car

e la singola regolazione di:

- volume
- numero gettoni
- velocità e frenata
- start e stop - pausa gioco
- tempo di durata del gioco



remote control  
telecomando START STOP  
cod. EX0-2452

STRAP only - solo CINTURINO  
cod. M-C001796



### EUROGAMES STANDARD TOKENS

Ø 24 mm - R14

GETTONI STANDARD  
cod. 0591

PACKAGE: 1.000 pieces  
Confezioni da 1.000 pezzi

Ask us for other available models  
Contattaci per altri gettoni disponibili

95 cm - 34 in  
48



SAFETY STOP  
STOP DI SICUREZZA  
cod. PA0-2336

stops ALL MINICARS  
ferma TUTTE le MINICAR



AGM BATTERY  
12 V - 80 Ah  
cod. 0617  
26 x 17 x 21cm  
10 x 7 x 8in



AGM BATTERY  
12 V - 120 Ah  
cod. 0618  
32 x 17 x 21cm  
13 X 7 X 8in

bumper boat/bumper car cover  
TELO bumper boat/bumper car  
cod. M-CE001394



# CHARGING STATION STAZIONI DI RICARICA

CHARGING TIME: up to 8h  
TEMPO DI RICARICA: fino a 8h

Holds up to 12 battery chargers programmable  
for either agm/hermetic/gel and lead acid

Contiene fino a 12 caricabatteria elettronici  
programmabili per batterie agm/ermetico/gel  
e piombo acido



**INDOOR cabinet  
MOD. PER INTERNO  
cod. PA5-0551**

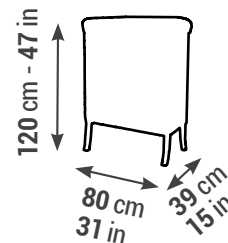

**OUTDOOR cabinet  
MOD. PER ESTERNO  
cod. PA5-0550**

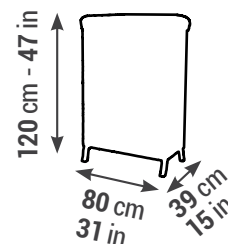

Outdoor and indoor.  
Per esterno e per interno.

cod. AC963  
only decoration  
Energy



## DECORATED - MOD. CON PORTA DECORATO

cod. AC957

GAS station



Rock



Pirate

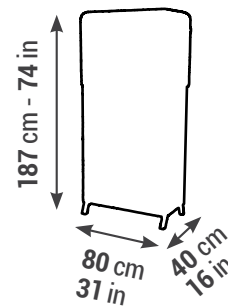



Eurogames srl  
Via degli Scavi, 41  
47122 Forlì - Italy  
tel. +39 0543 796665  
fax +39 0543 722727  
info@eurogames.it  
www.eurogames.it



R.I.S.E Dirk Vetter  
Am Rosenbusch 4, 40627 Düsseldorf  
Postanschrift: Rodenbecker Str. 56  
32427 Minden. [www.rise-consult.de](http://www.rise-consult.de)  
Tel.: 0571/597 28 328  
Mob.: 0171 1 986 986